

AVTEK

AST1200



avtek

Uchwyt ścienny do projektora

Projector Wall Mount

Projektor Wandhalterung

Support mural pour projecteur

Držák širokoúhlého projektoru

Držiak na širokouhlý projektor

Fali tartó a projektorhoz

Настенный кронштейн для проектора

Suport de perete pentru proiector

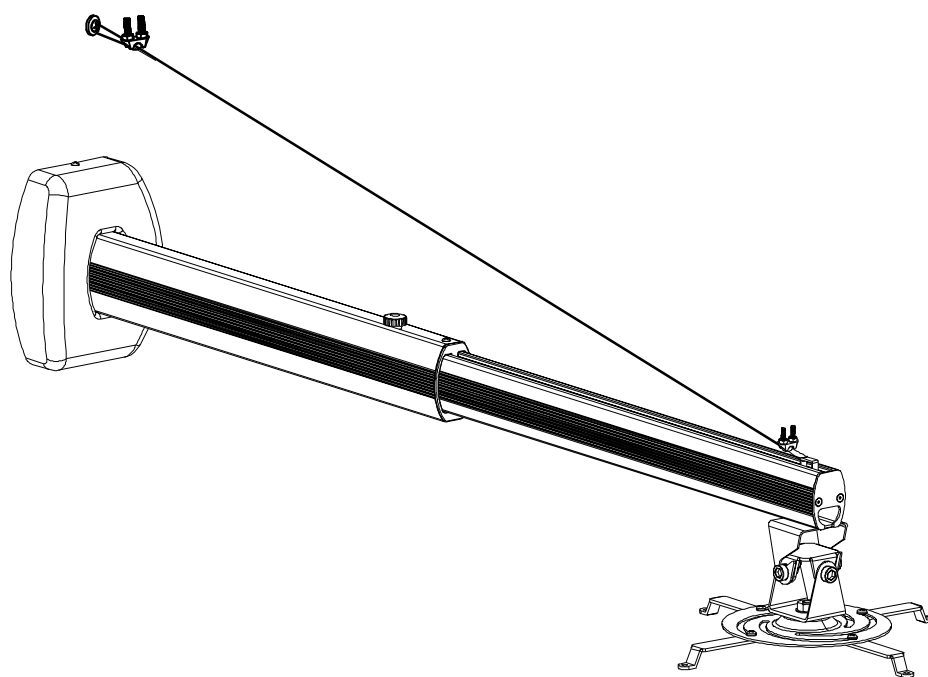

PL	Instrukcja montażu	2
EN	Installation instruction.....	4
DE	Gebrauchsanweisung	6
FR	Mode d'emploi	8
CZ	Návod k montáži	10
SK	Návod na montáž	12
HU	Telepítési útmutató	14
RU	Инструкция по монтажу	16
RO	Instrucțiuni de instalare	18

Uchwyt do projektora szerokokątnego - instrukcja montażu

Model: AST1200

Lista części

A M8X60 (X4)	B M4X8 (X2)	C S=2.5mm (X1)	D M4X8 (X7)	E M5X12 (X5)	F S=3mm (X1)	G M5X9 (X4)	H PW6.3X13X1(X4)	I M3X8 (X4)	J PW3.2X10 X1(X4)	K M8X16(X2)	L PW8.5X19X1(X2)	M S=6mm (X1)
N M4 (X6)	O M4X40 (X2)	P M3 (X6)	Q M3X40 (X2)	R X4	S X1	T X1	U X1	V X1	W X1			

Instalacja







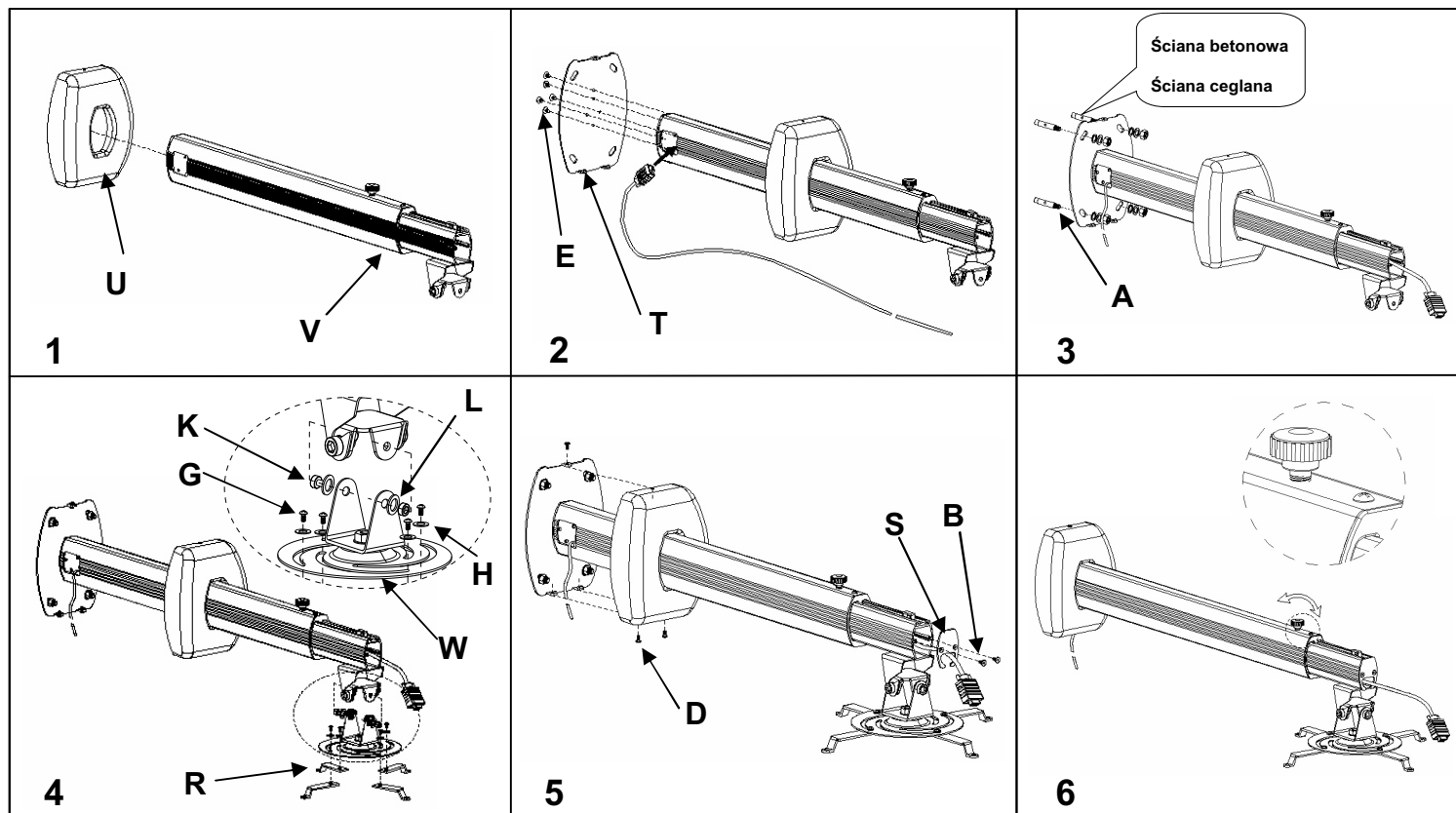



Uwaga!

Ten uchwyt do projektora szerokokątnego wolno instalować wyłącznie na murze ceglany lub betonowy przy użyciu załączonych przez producenta wkrętów.



Aluminiowy uchwyt do projektora szerokokątnego z linką odciążającą

Lista części

A	B	C	D	E	F	G	H
							
P.W5.0X16X2.2(X1)	M4X3(X4)	X2	M4(X2)	X1	X1	M4X45(X1)	S=6.8

Instalacja



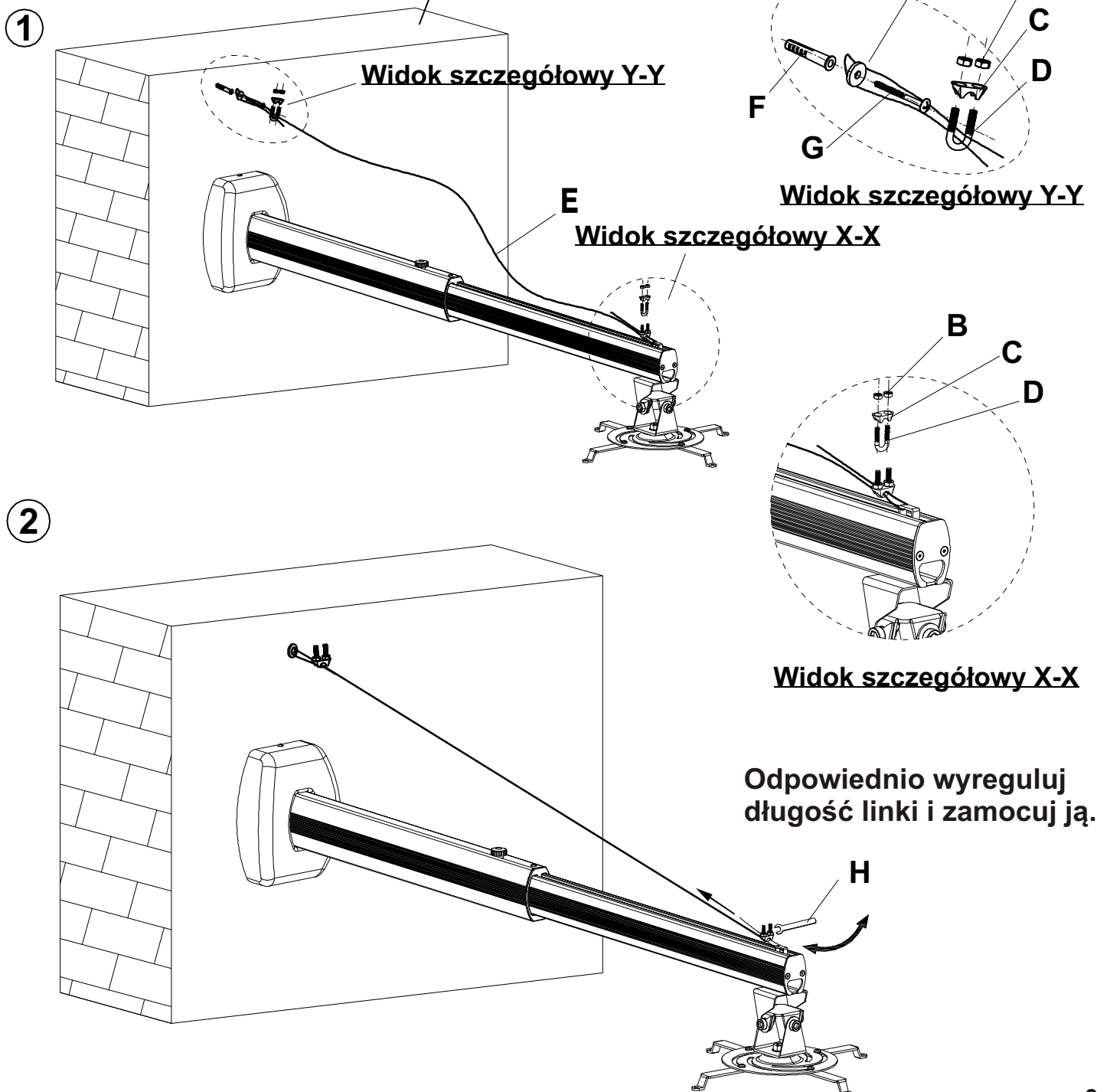

















Tylko ściana betonowa lub ceglana

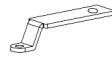

Short Throw Projector Mount Installation Instruction

Model: AST1200

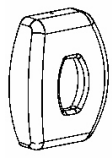
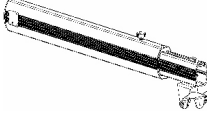
Parts List

A  M8X60 (X4)	B  M4X8 (X2)	C  S=2.5mm (X1)	D  M4X8 (X7)	E  M5X12 (X5)	F  S=3mm (X1)	G  M5X9 (X4)	H  PW6.3X13X1(X4)	I  M3X8 (X4)	J  PW3.2X10 X1(X4)	K  M8X16(X2)	L  PW8.5X19X1(X2)	M  S=6mm (X1)
N  M4 (X6)	O  M4X40 (X2)	P  M3 (X6)	Q  M3X40 (X2)	R  X4	S  X1	T  X1	U  X1	V  X1	W  X1			

Installation







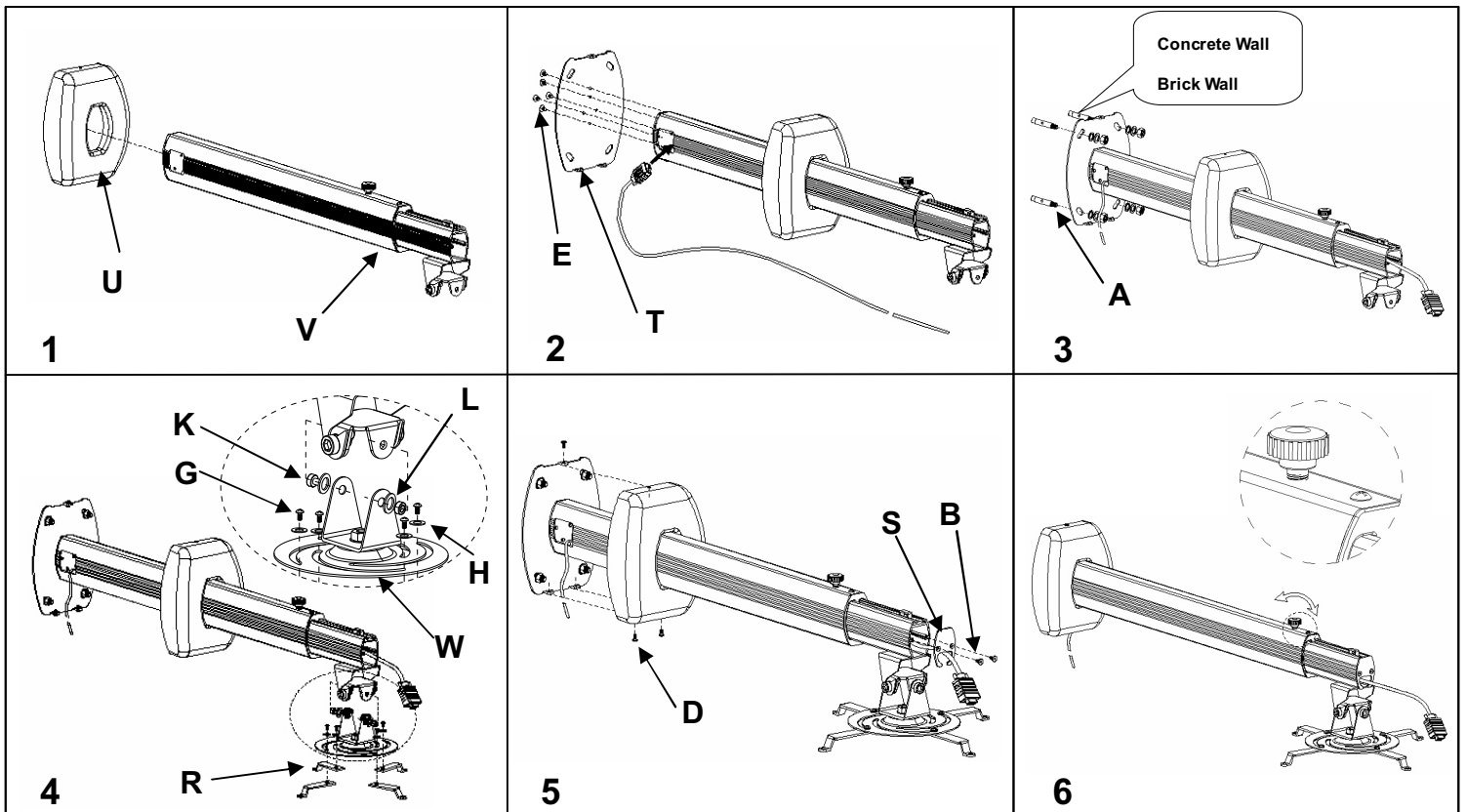



Notice!

This short throw projector mount should only be installed on concrete or brick wall with provided screws.



Aluminum Short Throw Projector Mount (Wire Installation)

Parts List

A	B	C	D	E	F	G	H
							
P.W5.0X16X2.2(X1)	M4X3(X4)	X2	M4(X2)	X1	X1	M4X45(X1)	S=6.8

Installation



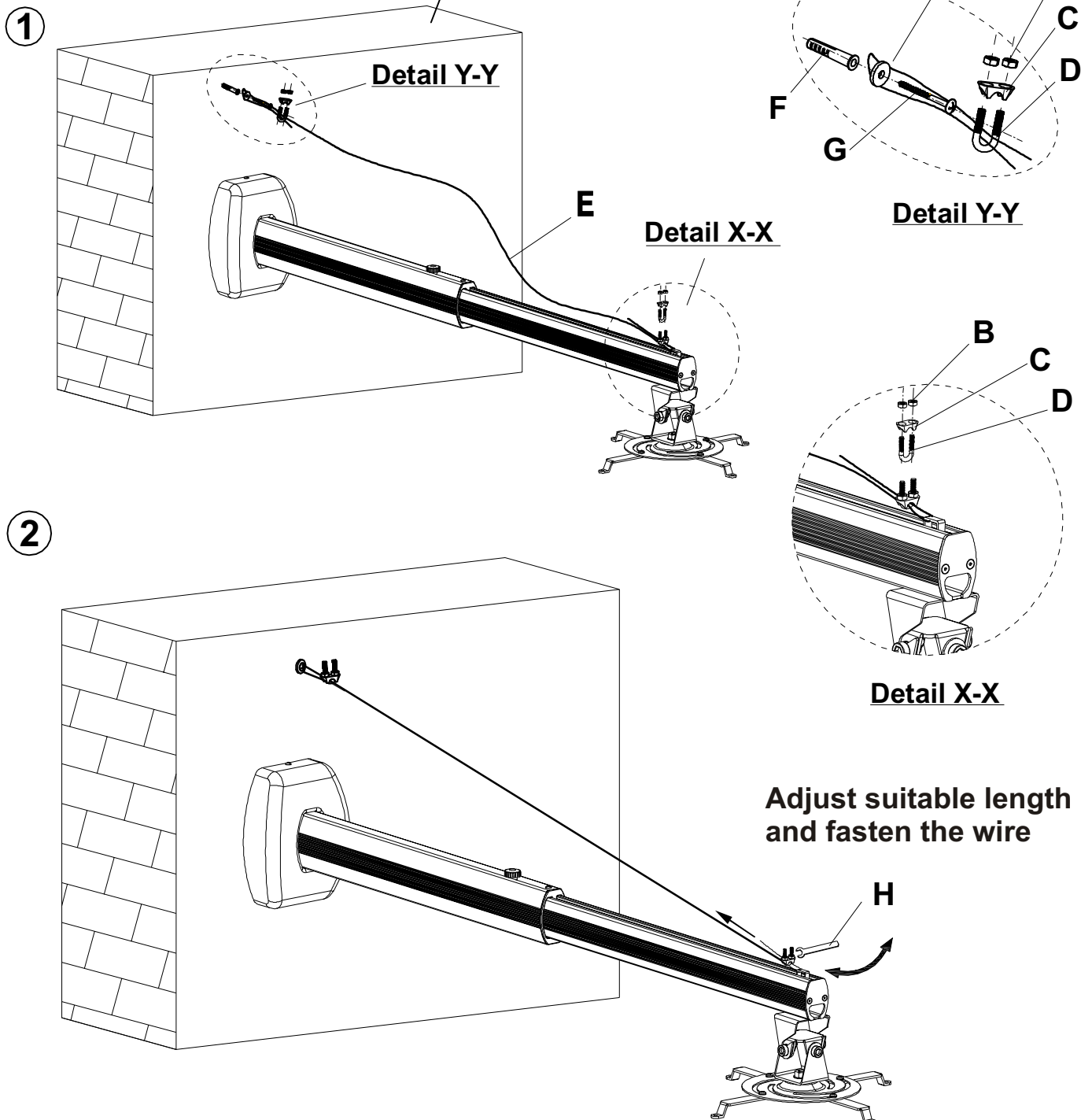

















Brick Wall or concrete wall only

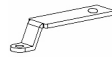

Kurz-Distanz Projektor Wandhalterung Gebrauchsanweisung

Modell: AST1200

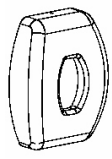
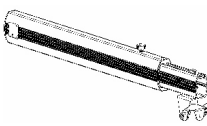
Teilliste

A  M8X60 (X4)	B  M4X8 (X2)	C  S=2.5mm (X1)	D  M4X8 (X7)	E  M5X12 (X5)	F  S=3mm (X1)	G  M5X9 (X4)	H  PW6.3X13X1(X4)	I  M3X8 (X4)	J  PW3.2X10 X1(X4)	K  M8X16(X2)	L  PW8.5X19X1(X2)	M  S=6mm (X1)
N  M4 (X6)	O  M4X40 (X2)	P  M3 (X6)	Q  M3X40 (X2)	R  X4	S  X1	T  X1	U  X1	V  X1	W  X1			

Installation







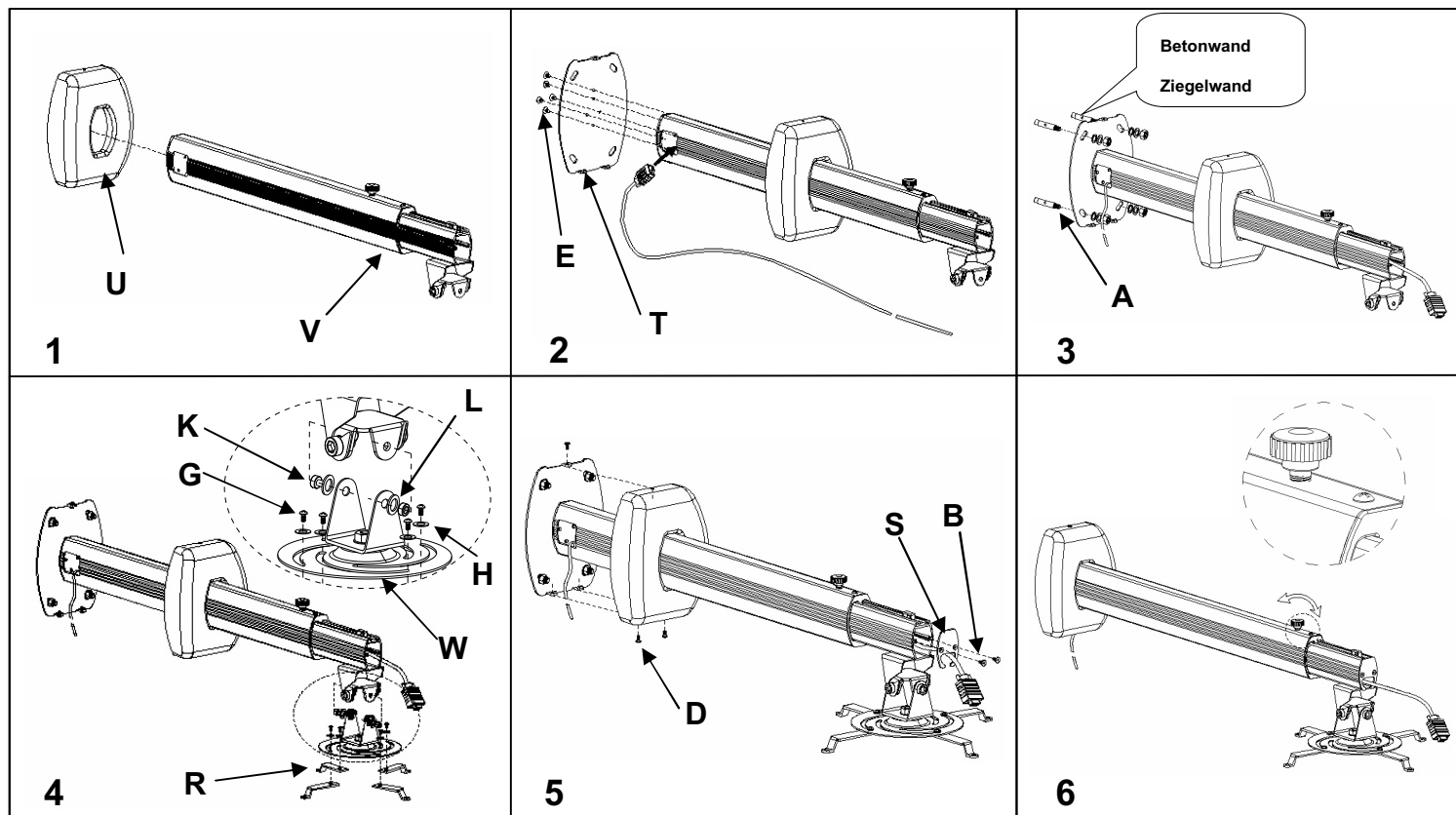



Achtung!

Diese Wandhalterung für Kurz-Distanz Projektor darf nur auf Beton- oder Ziegelwand mit den angeschlossenen Schrauben installiert werden.



Aluminiumhalterung für Weitwinkel-Projektor mit Entlastungsseil

Teilliste

A	B	C	D	E	F	G	H
							
P.W5.0X16X2.2(X1)	M4X3(X4)	X2	M4(X2)	X1	X1	M4X45(X1)	S=6.8

Installation



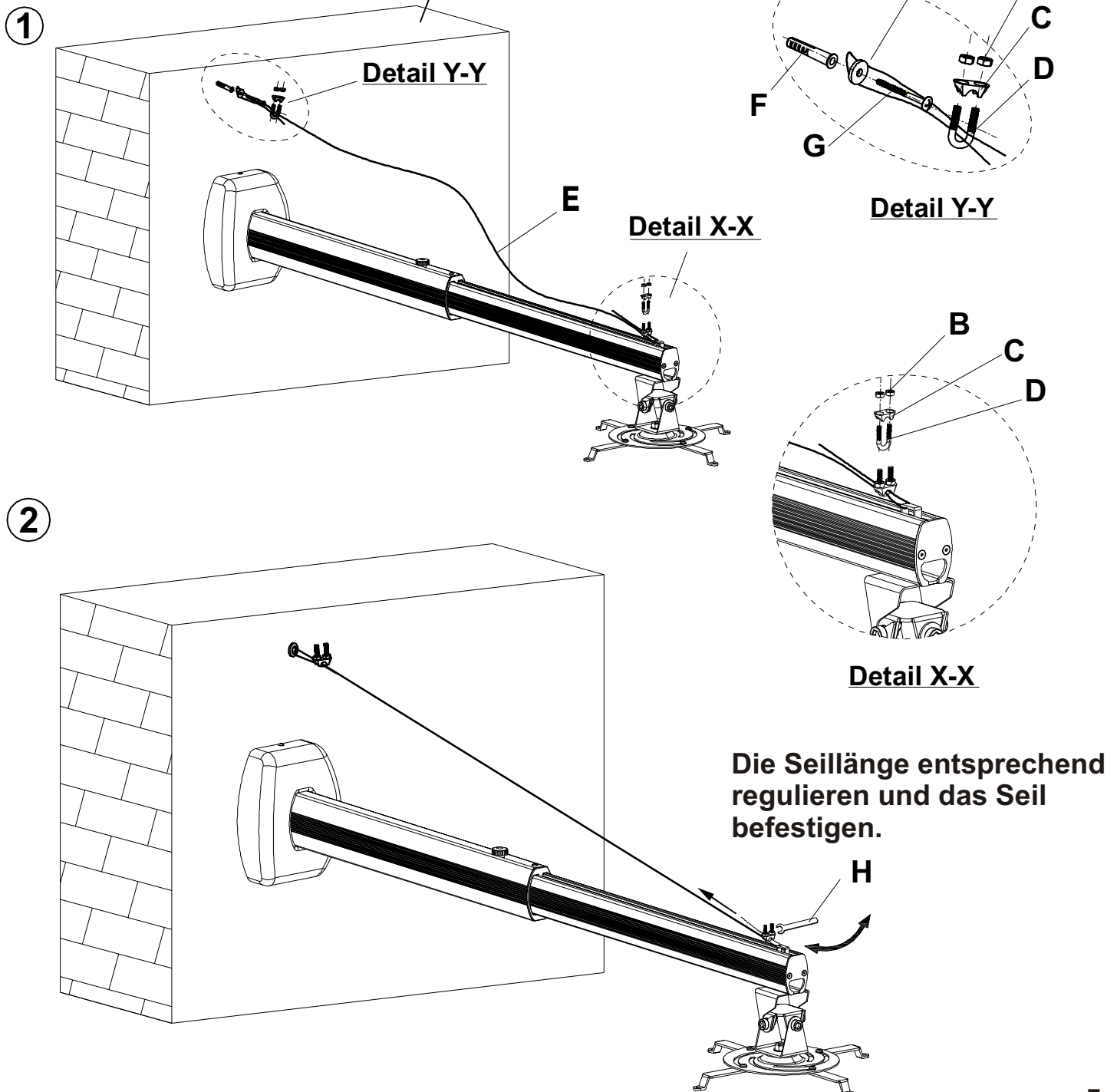

















Nur Beton- oder Ziegelwand

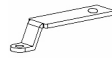

Support mural pour projecteur à focale ultra-courte

Mode d'emploi - Modèle: AST1200

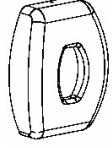
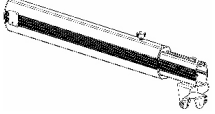
Liste des pièces

A  M8X60 (X4)	B  M4X8 (X2)	C  S=2.5mm (X1)	D  M4X8 (X7)	E  M5X12 (X5)	F  S=3mm (X1)	G  M5X9 (X4)	H  PW6.3X13X1(X4)	I  M3X8 (X4)	J  PW3.2X10 X1(X4)	K  M8X16(X2)	L  PW8.5X19X1(X2)	M  S=6mm (X1)
N  M4 (X6)	O  M4X40 (X2)	P  M3 (X6)	Q  M3X40 (X2)	R  X4	S  X1	T  X1	U  X1	V  X1	W  X1			

Installation







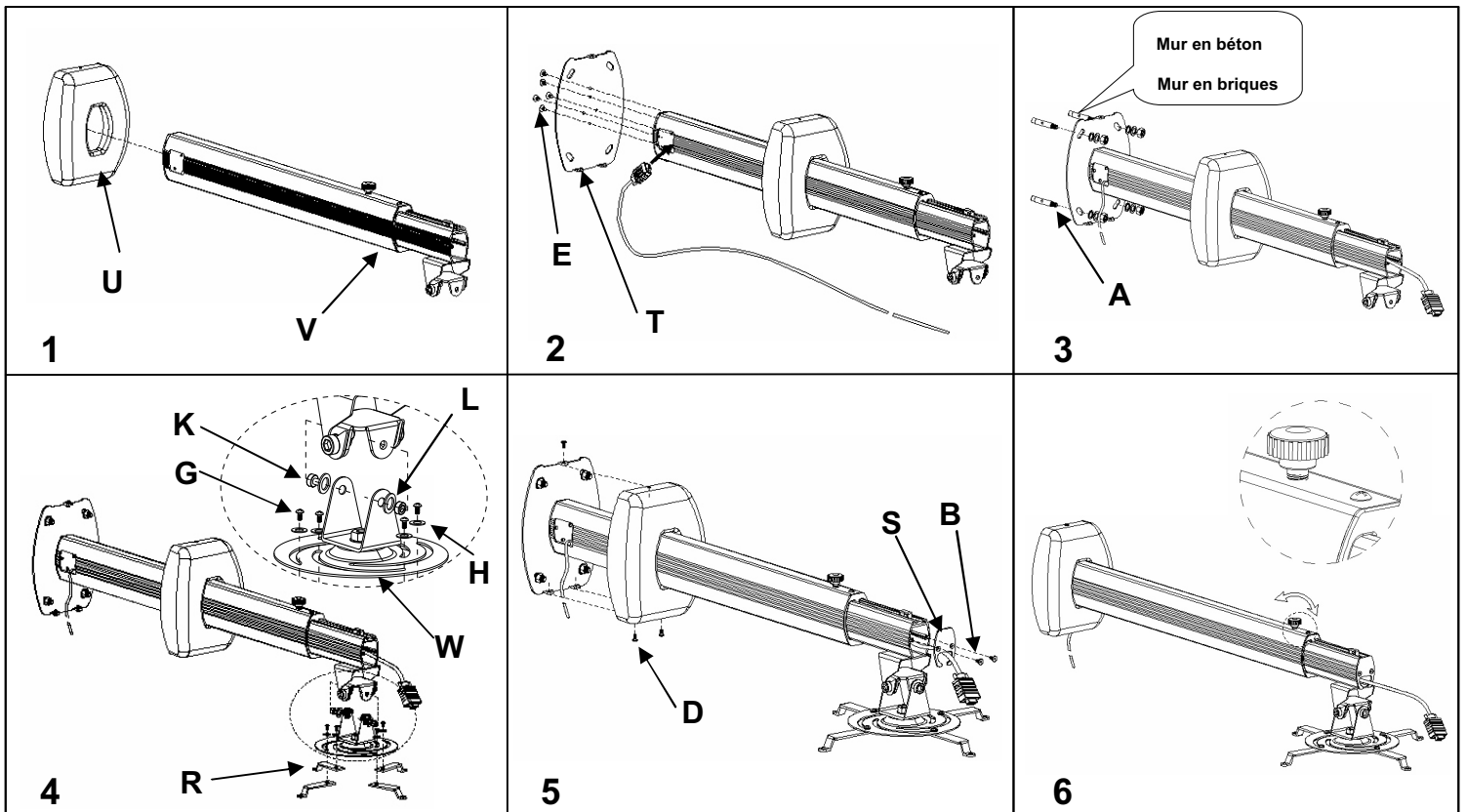



Attention!

Ce support mural du projecteur à focale ultra-courte peut être installé uniquement sur un mur en briques ou en béton à l'aide des vis fournies par le producteur.

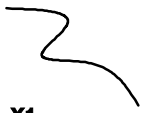

Support mural en aluminium avec cable d'ancrage pour projecteur à focale ultra-courte

Liste des pièces

A	B	C	D	E	F	G	H
							
P.W5.0X16X2.2(X1)	M4X3(X4)	X2	M4(X2)	X1	X1	M4X45(X1)	S=6.8

Installation

Uniquement mur en béton ou en briques

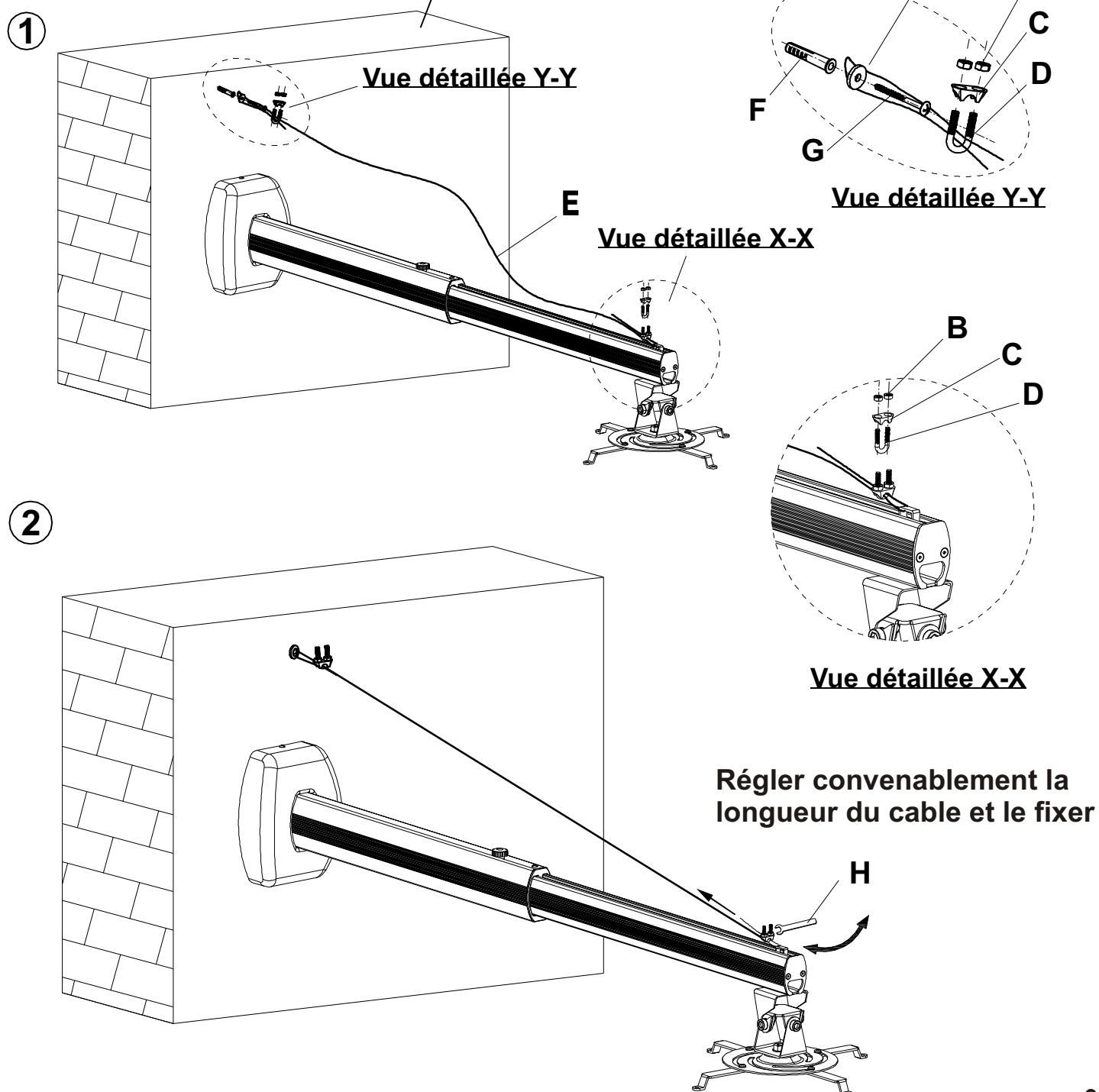

Držák širokoúhlého projektoru – návod k montáži

Model: AST1200

Seznam dílů

A M8X60 (X4)	B M4X8 (X2)	C S=2.5mm (X1)	D M4X8 (X7)	E M5X12 (X5)	F S=3mm (X1)	G M5X9 (X4)	H PW6.3X13X1(X4)	I M3X8 (X4)	J PW3.2X10 X1(X4)	K M8X16(X2)	L PW8.5X19X1(X2)	M S=6mm (X1)
N M4 (X6)	O M4X40 (X2)	P M3 (X6)	Q M3X40 (X2)	R X4	S X1	T X1	U X1	V X1	W X1			

Instalace







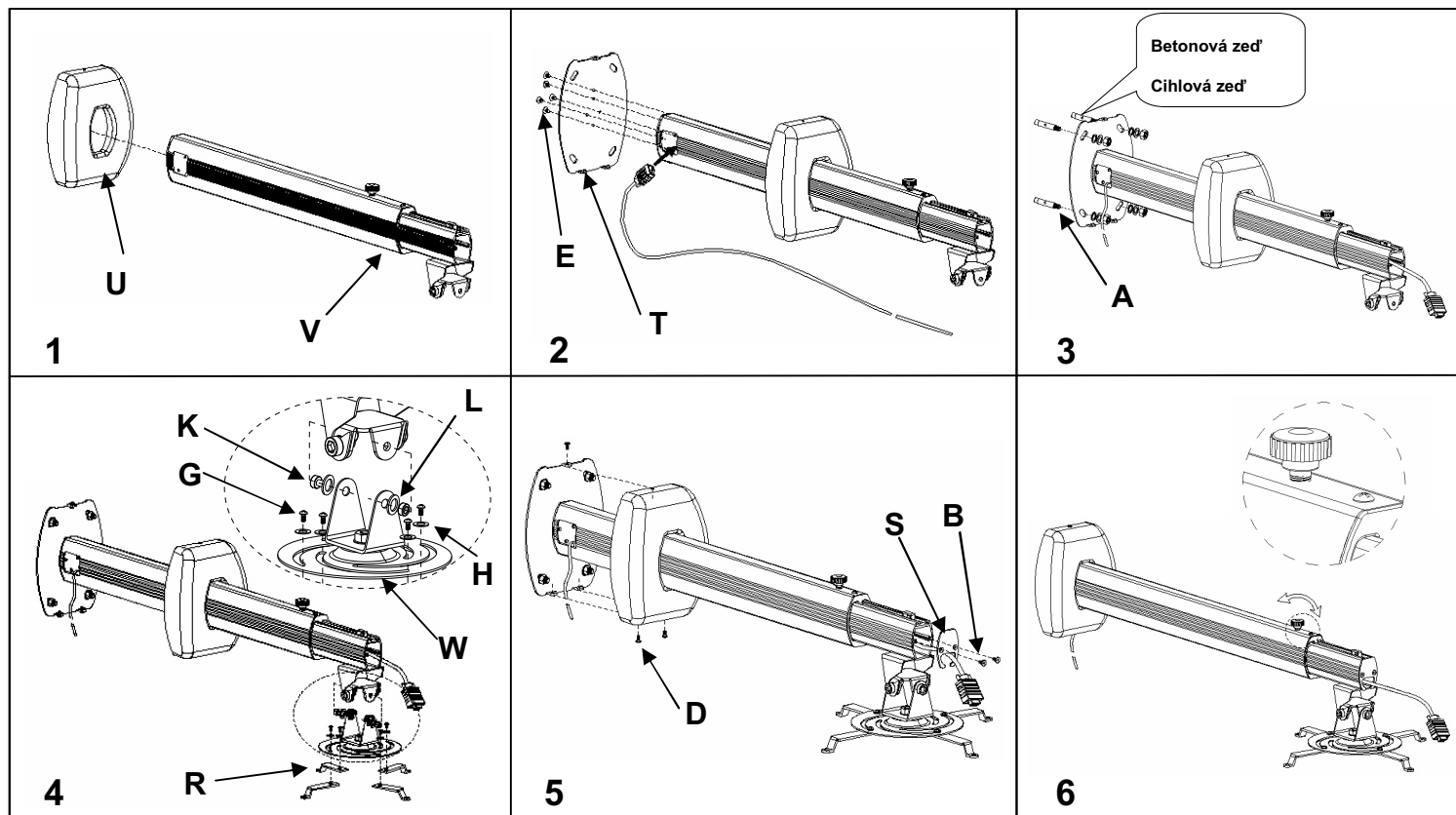



Upozornění!

Tento držák širokoúhlého projektoru se smí instalovat pouze na cihlové nebo betonové zdi a jen za použití výrobcem přiložených šroubů.

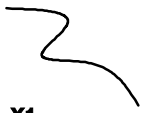

Hliníkový držák širokoúhlého projektoru s odlehčujícím lankem

Seznam dílů

A	B	C	D	E	F	G	H
							
P.W5.0X16X2.2(X1)	M4X3(X4)	X2	M4(X2)	X1	X1	M4X45(X1)	S=6.8

Instalace

Jen betonová nebo cihlová zeď

①

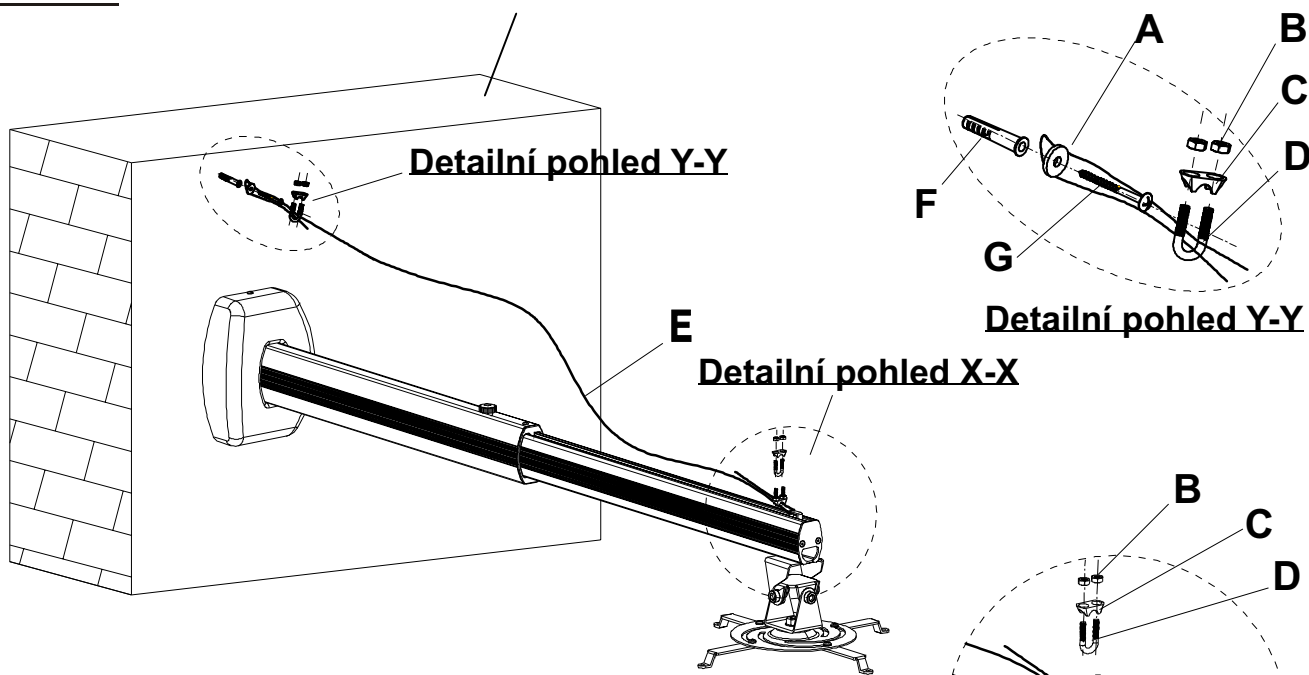



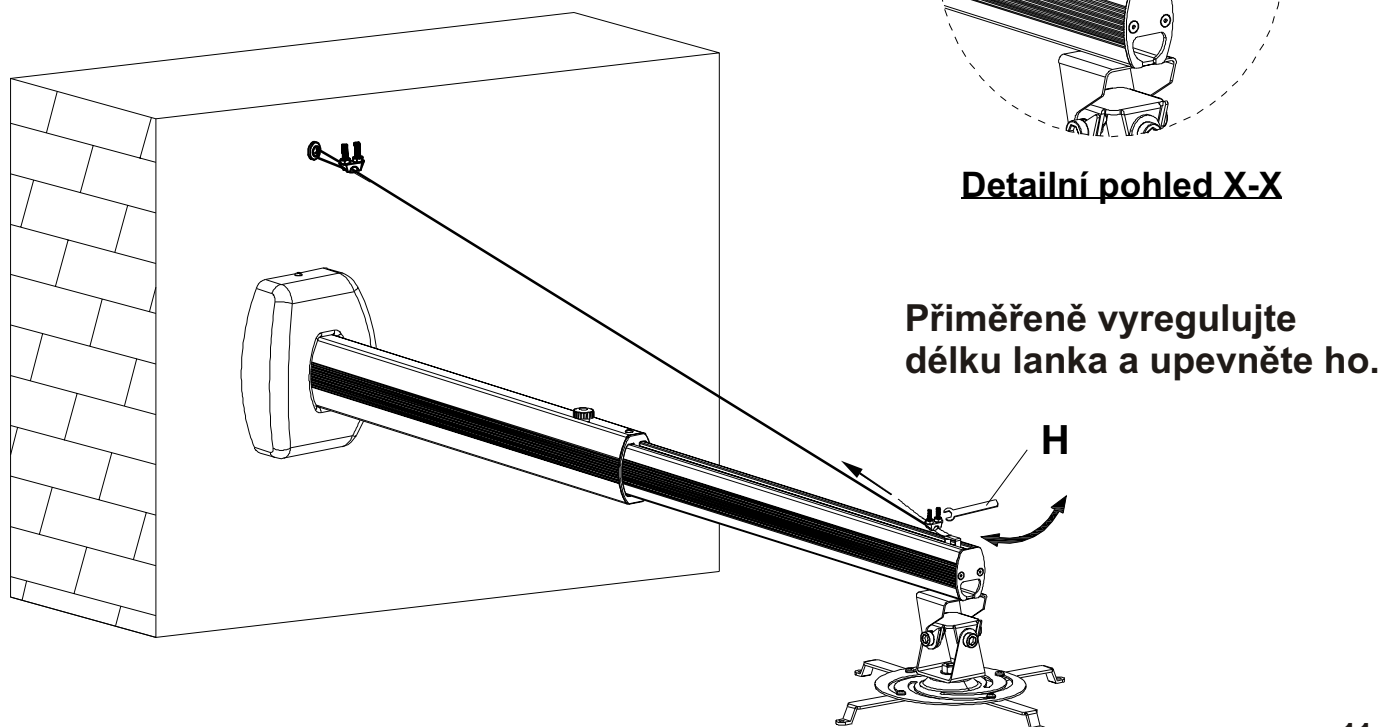

















②

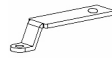

Držiak na širokouhlý projektor – návod na montáž

Model: AST1200

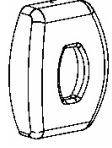
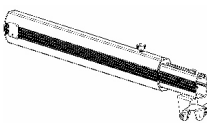
Zoznam dielov

A  M8X60 (X4)	B  M4X8 (X2)	C  S=2.5mm (X1)	D  M4X8 (X7)	E  M5X12 (X5)	F  S=3mm (X1)	G  M5X9 (X4)	H  PW6.3X13X1(X4)	I  M3X8 (X4)	J  PW3.2X10 X1(X4)	K  M8X16(X2)	L  PW8.5X19X1(X2)	M  S=6mm (X1)
N  M4 (X6)	O  M4X40 (X2)	P  M3 (X6)	Q  M3X40 (X2)	R  X4	S  X1	T  X1	U  X1	V  X1	W  X1			

Inštalácia







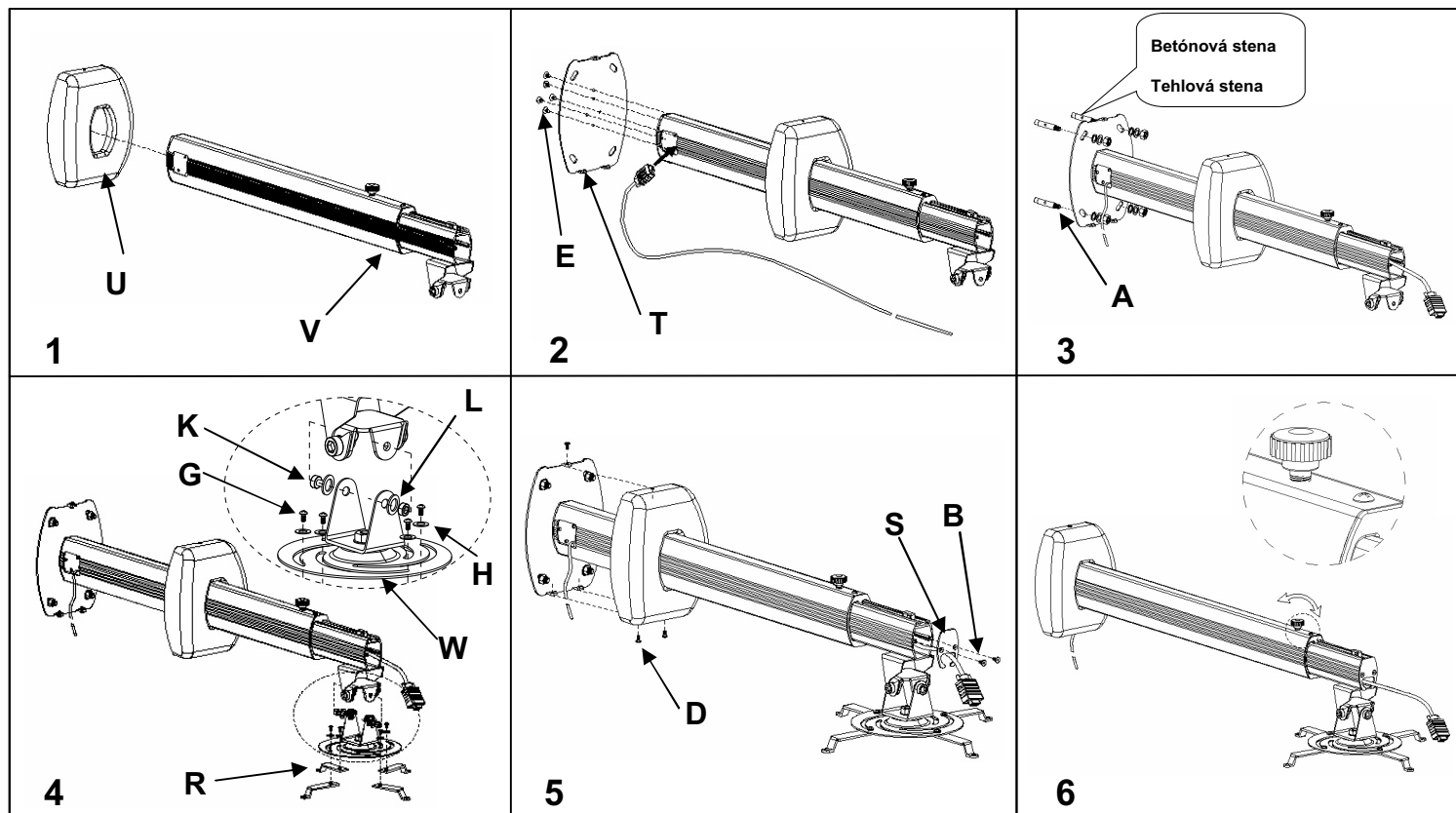



Upozornenie!

Tento držiak na širokouhlý projektor sa smie inštalovať výlučne na tehlovom alebo betónovom múre a len s použitím výrobcom priložených skrutiek.

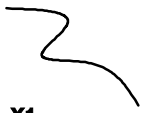

Hliníkový držiak na širokouhľý projektor s odľahčujúcim lankom

Zoznam dielov

A	B	C	D	E	F	G	H
							
P.W5.0X16X2.2(X1)	M4X3(X4)	X2	M4(X2)	X1	X1	M4X45(X1)	S=6.8

Inštalácia

Len betónová alebo tehlová stena

①

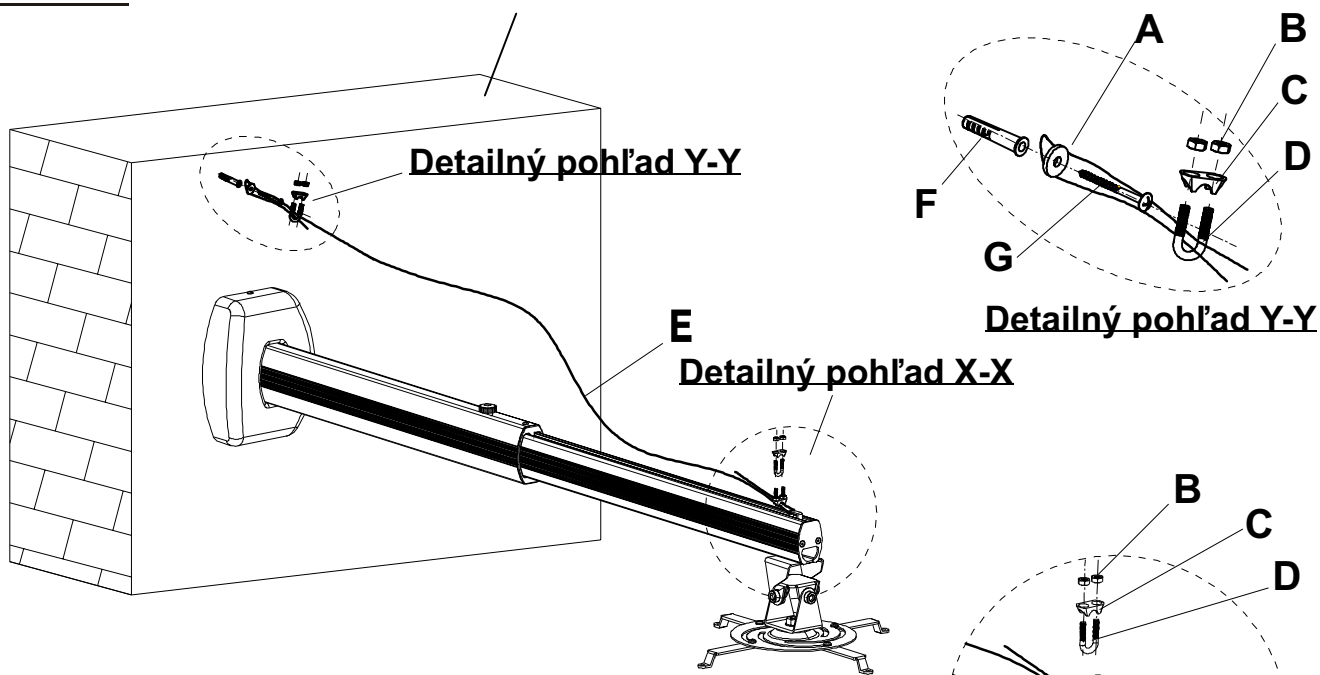



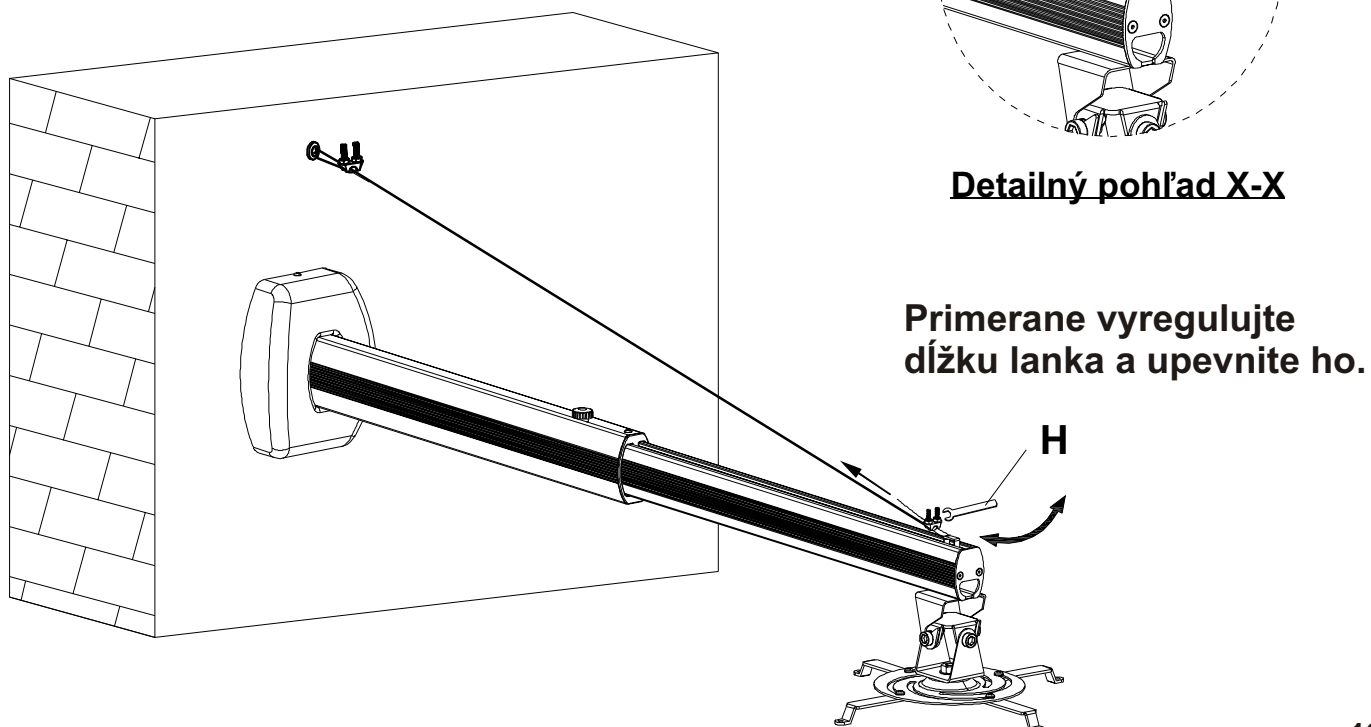

















②

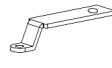

Tartó nagylátószögű projektorhoz telepítési útmutató

Model: AST1200

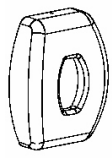
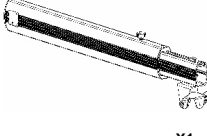
Alkatrész lista

A  M8X60 (X4)	B  M4X8 (X2)	C  S=2.5mm (X1)	D  M4X8 (X7)	E  M5X12 (X5)	F  S=3mm (X1)	G  M5X9 (X4)	H  PW6.3X13X1(X4)	I  M3X8 (X4)	J  PW3.2X10 X1(X4)	K  M8X16(X2)	L  PW8.5X19X1(X2)	M  S=6mm (X1)
N  M4 (X6)	O  M4X40 (X2)	P  M3 (X6)	Q  M3X40 (X2)	R  X4	S  X1	T  X1	U  X1	V  X1	W  X1			

Telepítés







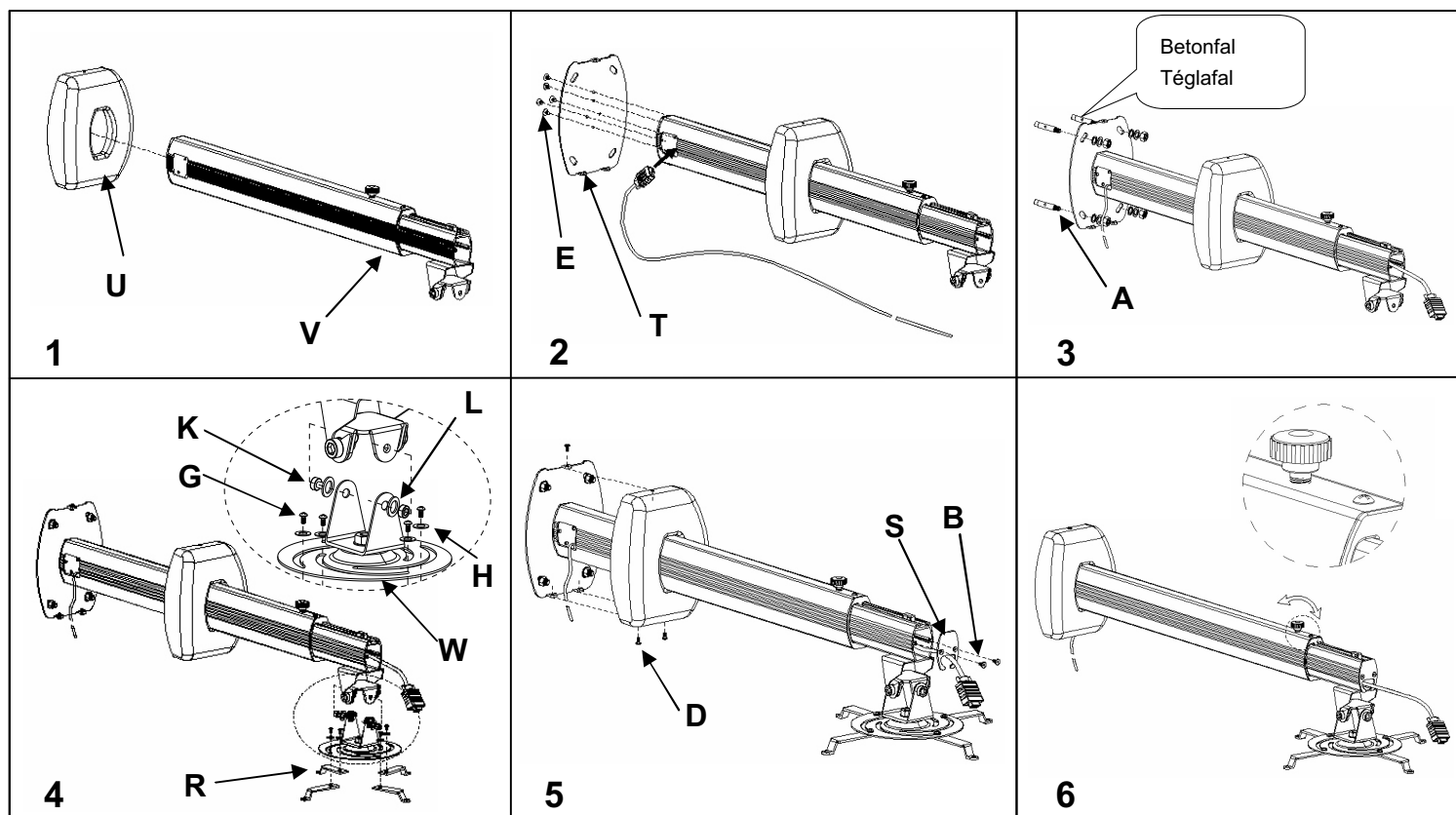



Figyelem!

Ezt a nagylátószögű projektorhoz való tartót kizárólag téglából vagy betonból készült falra szabad felszerelni, a gyártó által a készlethez mellékelt csavarok segítségével.

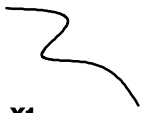

Tartó nagylátószögű projektorhoz (tehermentesítő kötél)

Alkatrészlista

A	B	C	D	E	F	G	H
							
P.W5.0X16X2.2(X1)	M4X3(X4)	X2	M4(X2)	X1	X1	M4X45(X1)	S=6.8

Telepítés

Kizárólag beton- vagy téglafalra telepíthető

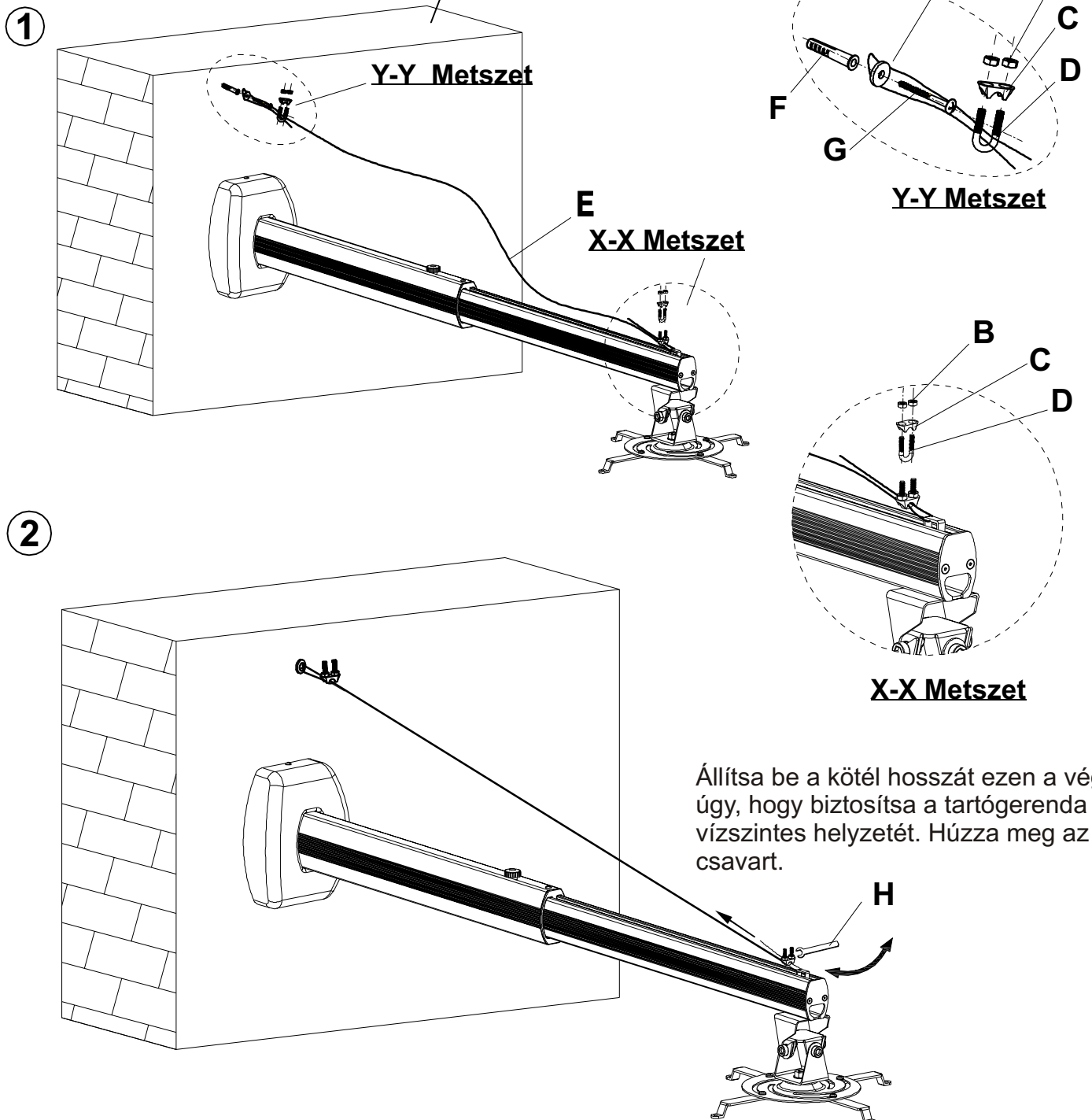

Кронштейн для широкоугольного проектора - инструкция по монтажу

Модель AST1200

Список составляющих частей

A M8X60 (X4)	B M4X8 (X2)	C S=2.5mm (X1)	D M4X8 (X7)	E M5X12 (X5)	F S=3mm (X1)	G M5X9 (X4)	H PW6.3X13X1 (X4)	I M3X8 (X4)	J PW3.2X10 X1 (X4)	K M8X16 (X2)	L PW8.5X19X1 (X2)	M S=6mm (X1)
N M4 (X6)	O M4X40 (X2)	P M3 (X6)	Q M3X40 (X2)	R X4	S X1	T X1	U X1	V X1	W X1			

Монтаж







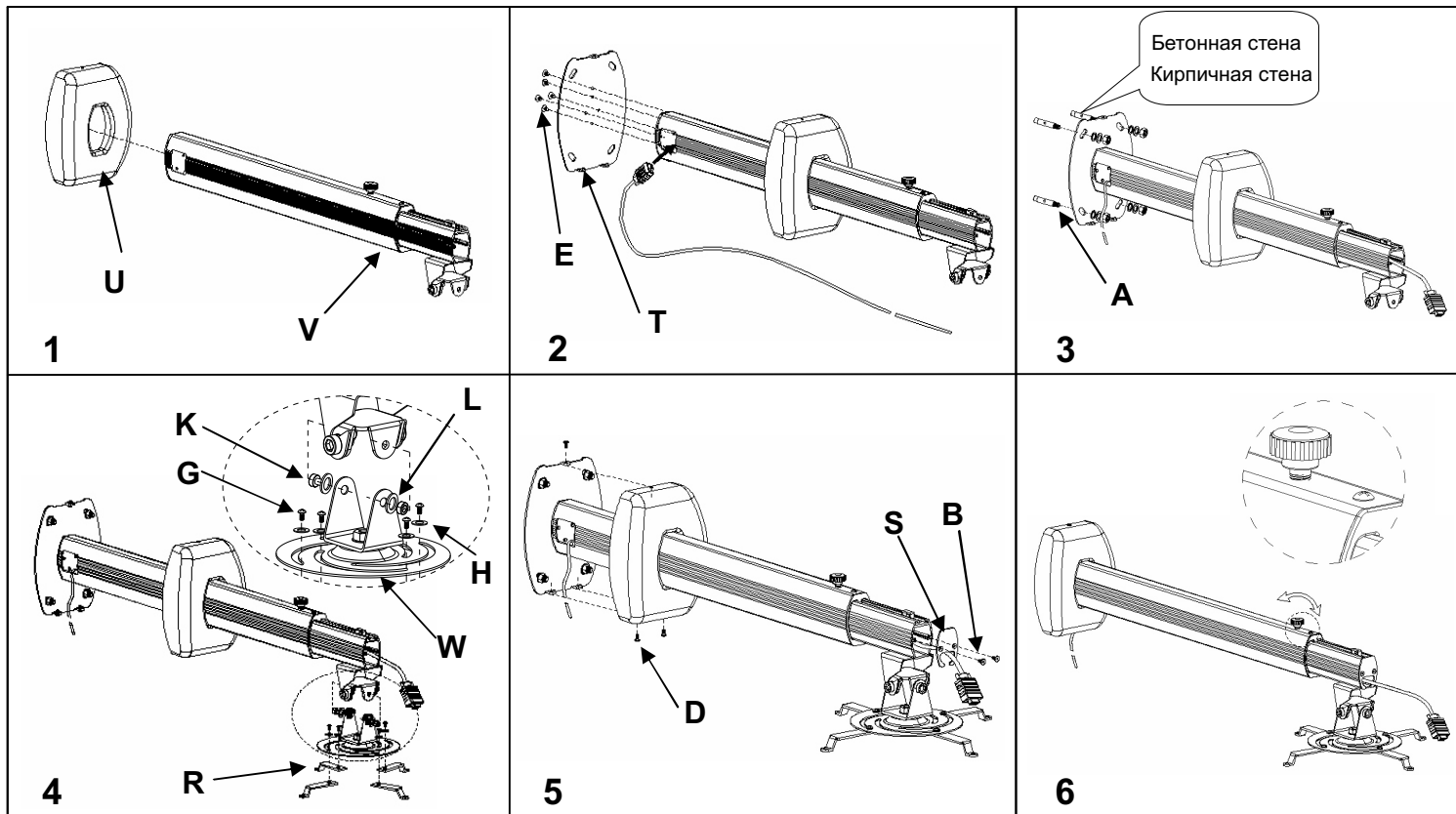



Внимание

Данный кронштейн для широкоугольного проектора можно закреплять исключительно на кирпичной или бетонной стене с помощью шурупов, прилагаемых производителем.

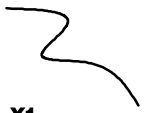

Кронштейн для широкоугольного проектора (нагрузочный кабель)

Список составляющих частей

A	B	C	D	E	F	G	H
							
P.W5.0X16X2.2(X1)	M4X3(X4)	X2	M4(X2)	X1	X1	M4X45(X1)	S=6.8

Монтаж

Монтаж исключительно на бетонной или кирпичной стене

①

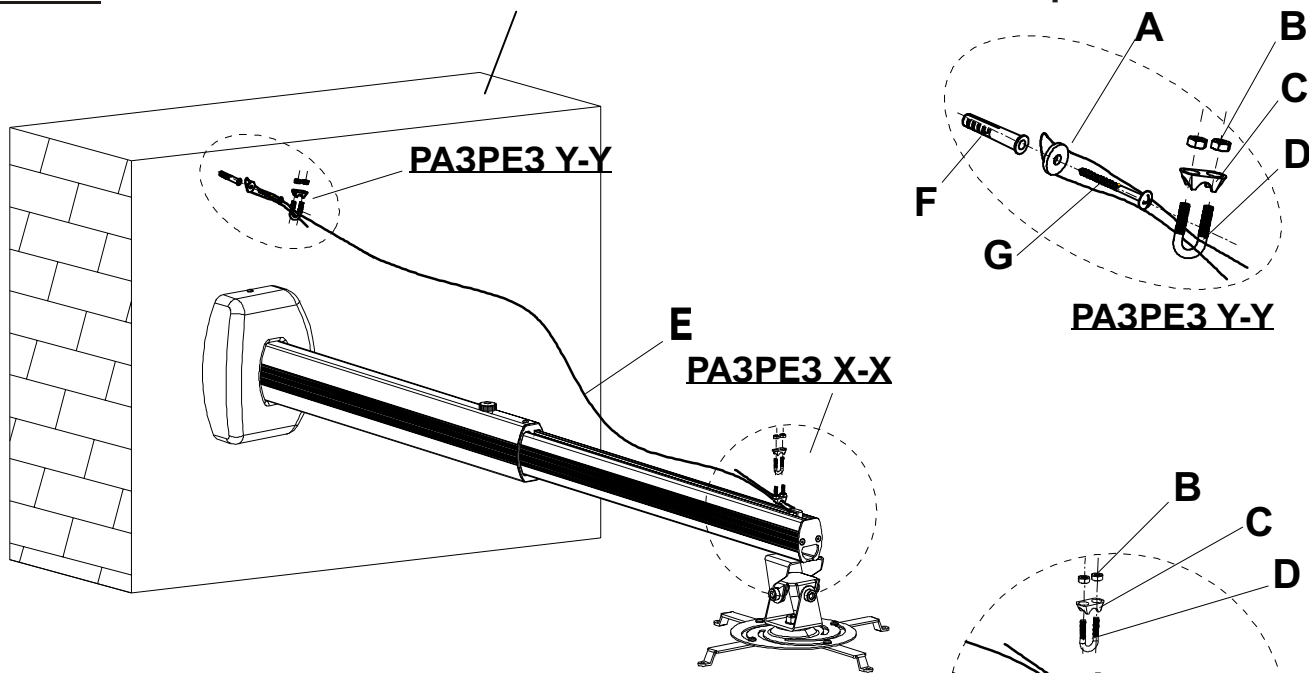



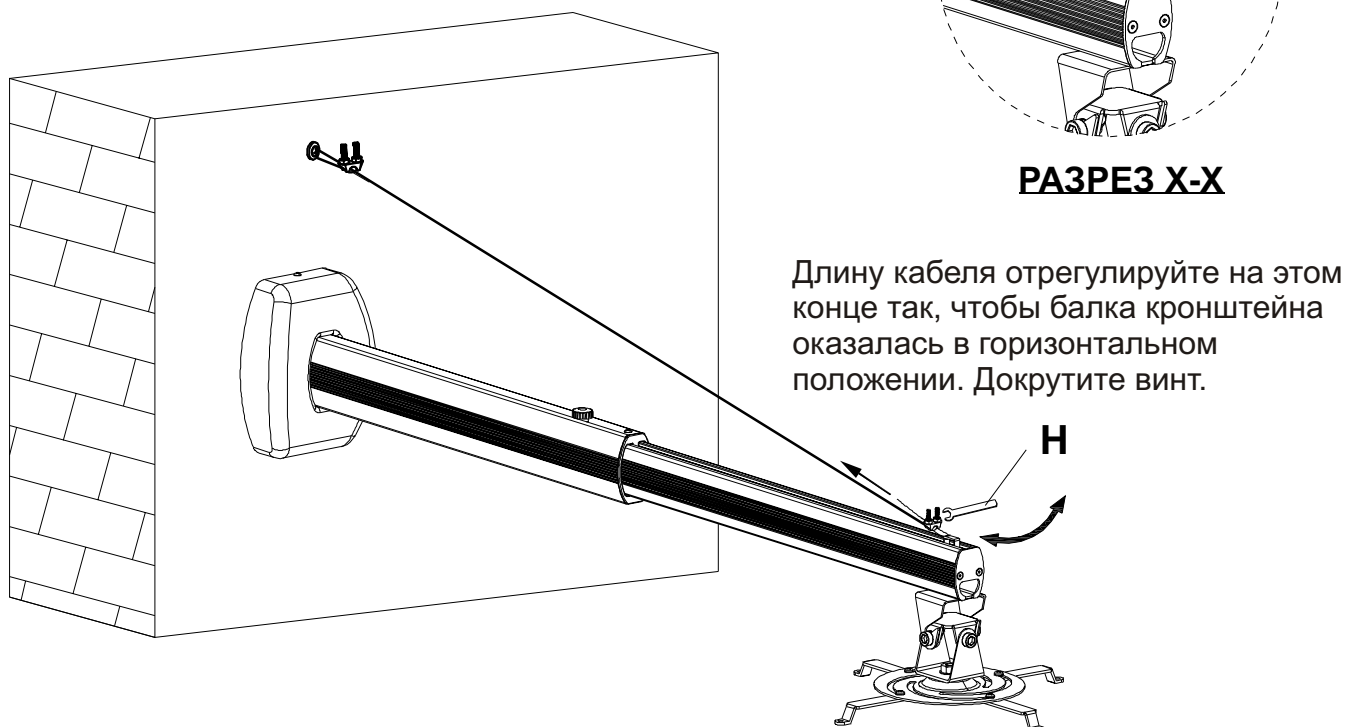



















②



Suport pentru proiector cu unghi larg - instrucțiuni de instalare

Model: AST1200

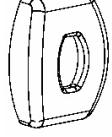
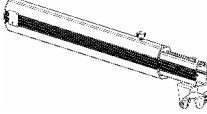
Lista pieselor

A  M8X60 (X4)	B  M4X8 (X2)	C  S=2.5mm (X1)	D  M4X8 (X7)	E  M5X12 (X5)	F  S=3mm (X1)	G  M5X9 (X4)	H  PW6.3X13X1(X4)	I  M3X8 (X4)	J  PW3.2X10 X1(X4)	K  M8X16(X2)	L  PW8.5X19X1(X2)	M  S=6mm (X1)
N  M4 (X6)	O  M4X40 (X2)	P  M3 (X6)	Q  M3X40 (X2)	R  X4	S  X1	T  X1	U  X1	V  X1	W  X1			

Instalarea







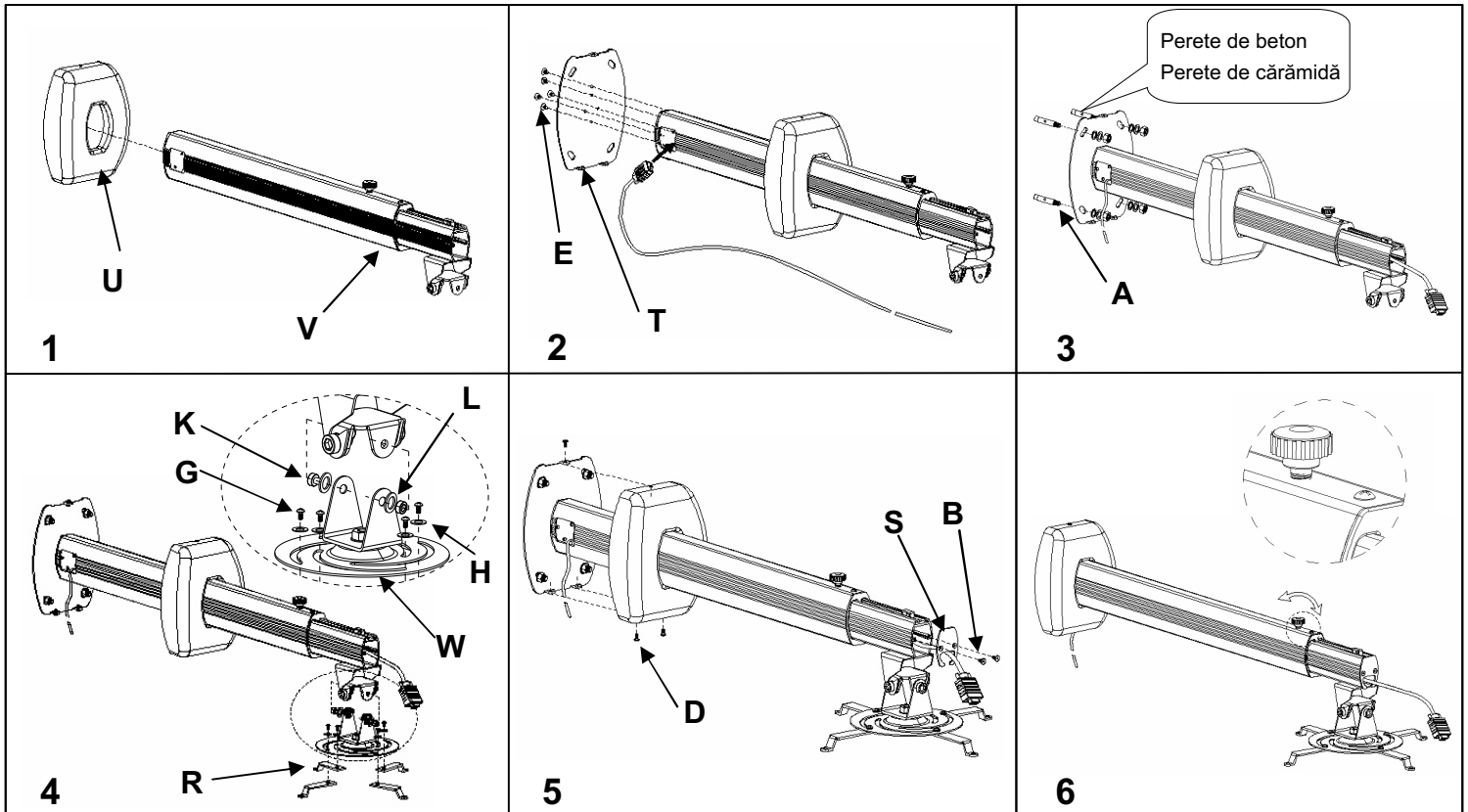



Atenție!

Acest suport pentru proiector cu unghi larg poate fi instalat doar pe perete de cărămidă sau beton cu ajutorul șuruburilor atașate de către producător.

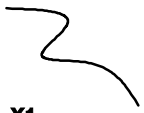

Suport pentru proiector cu unghi larg (cordon de eliberare)

Lista pieselor

A	B	C	D	E	F	G	H
							
P.W5.0X16X2.2(X1)	M4X3(X4)	X2	M4(X2)	X1	X1	M4X45(X1)	S=6.8

Instalarea

Instalarea doar pe perete de beton sau cărămidă

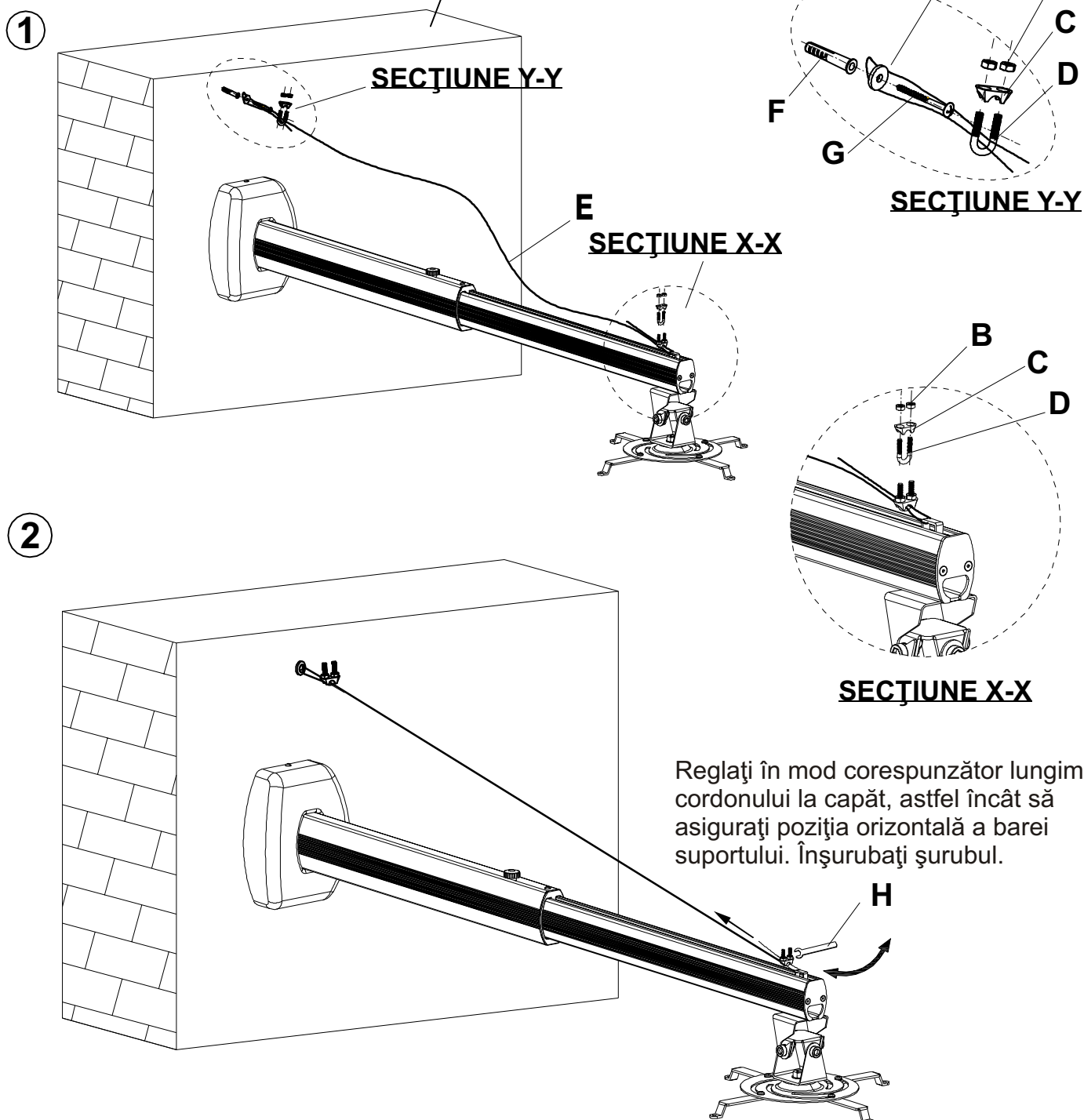



avtek

<http://www.avtek.eu>